

**Nr 1**

|            |         |    |
|------------|---------|----|
| <b>T10</b> |         | x3 |
| <b>T13</b> |         | x3 |
|            | 8x50 mm |    |
| <b>K2</b>  |         | x9 |
|            | φ 7x70  |    |
| <b>C3</b>  |         | x3 |

Tabelle mit Maßen/Menge  
 und Colli-Nr. der Einzelteile

| NO | Dim.     | Col.-No | Qty |
|----|----------|---------|-----|
| 1  | 1800 220 | 1       | 1   |
| 2  | 1600 200 | 1       | 1   |

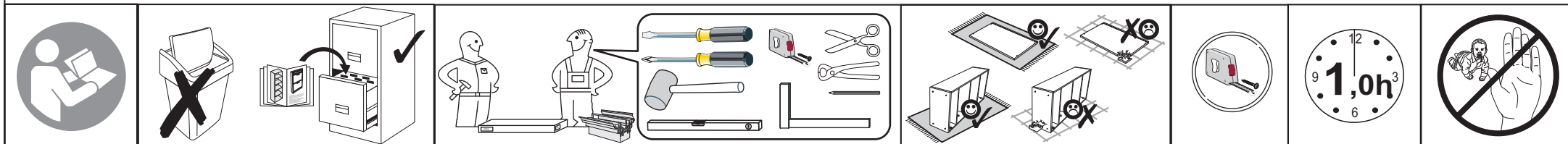

Modellname:  
Nazwa modelu:

# TERRA PLUS

Modellreihe:  
Numer modelu: **4040--40**

Type: **40**  
Typ:

Blatt Nr: **2** von: **4**  
Strona: **z:**

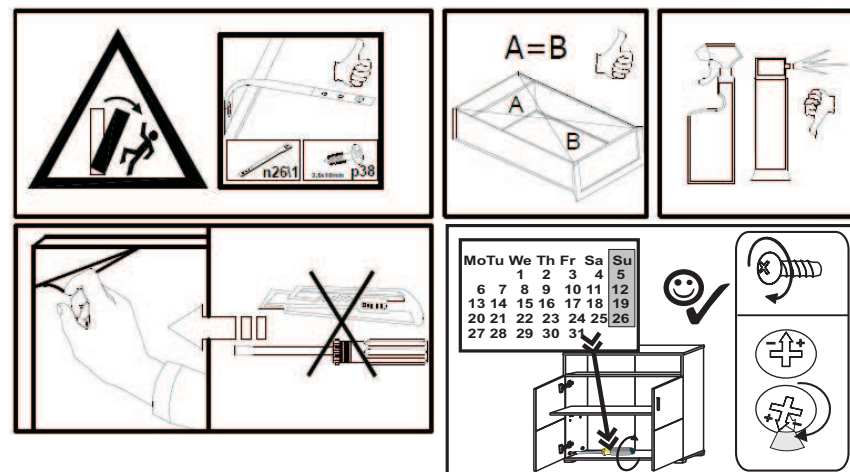
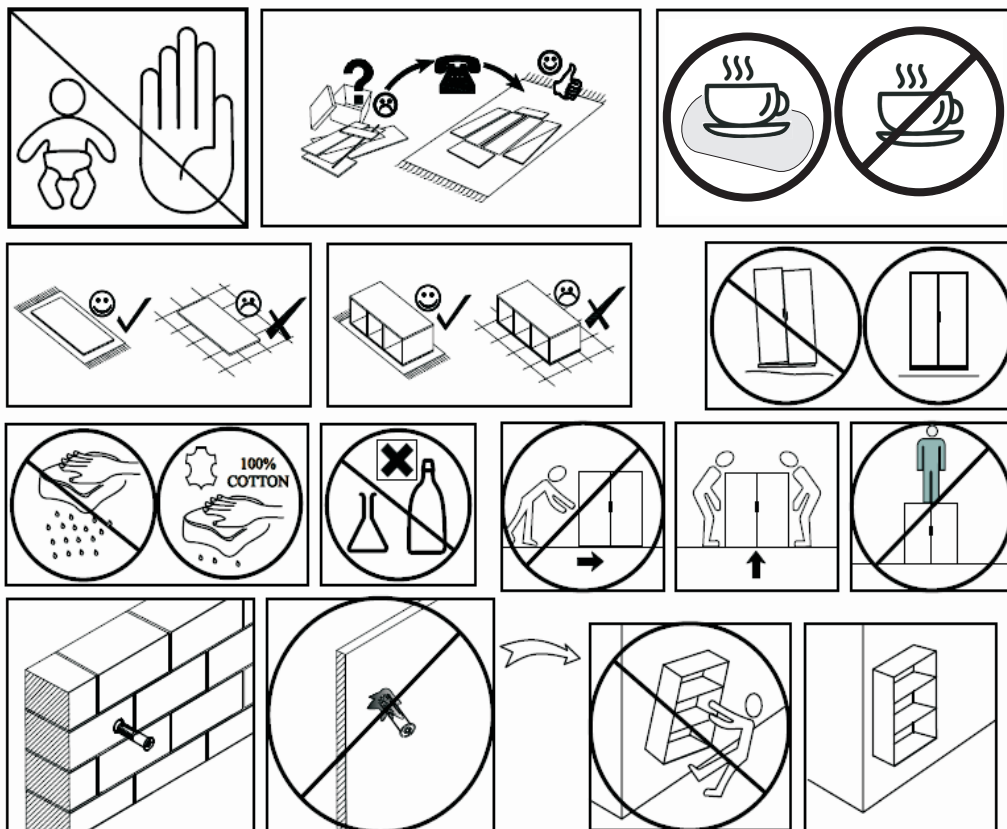
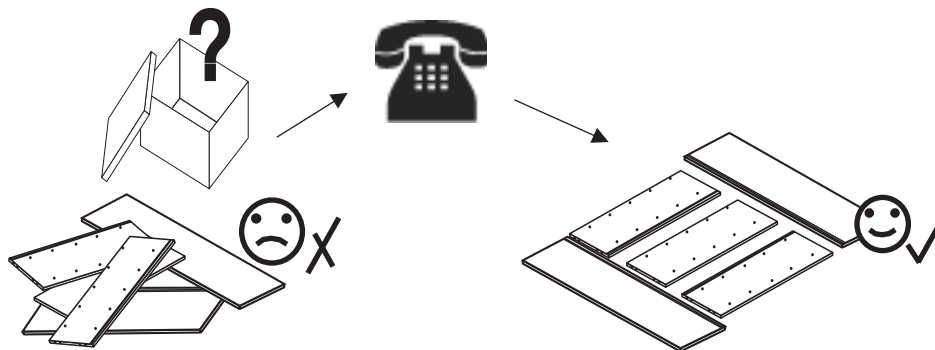

**1**

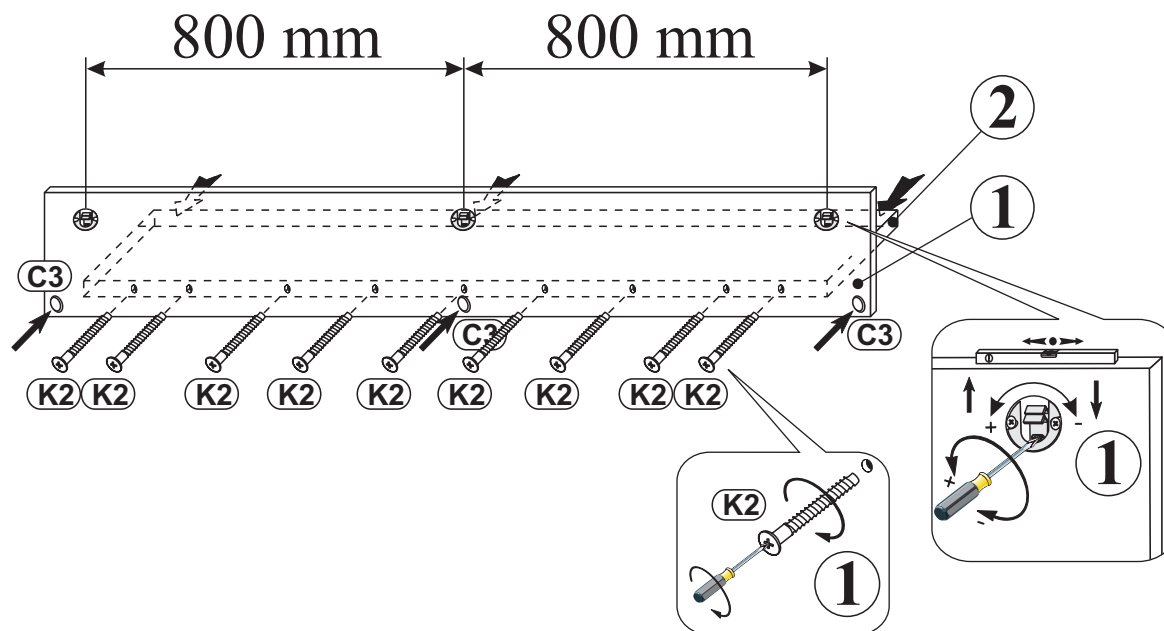
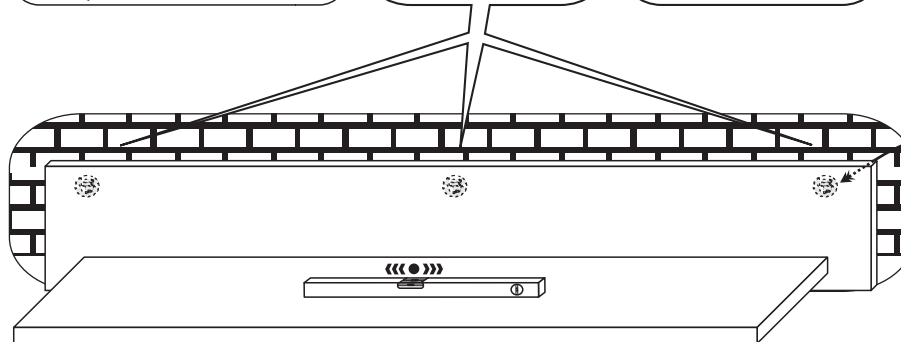
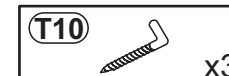
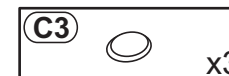
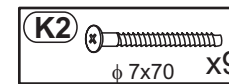
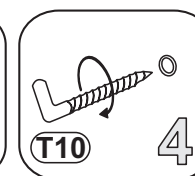
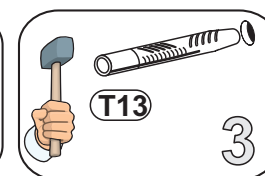
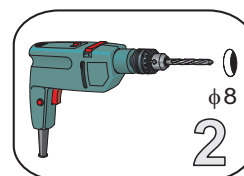
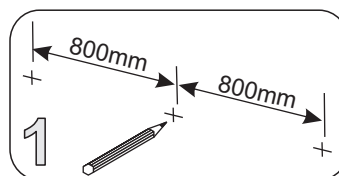
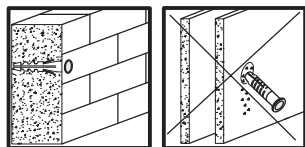
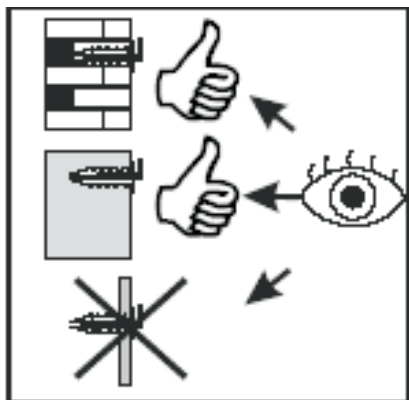

Modellname:  
Nazwa modelu:

**TERRA PLUS**

Modellreihe:  
Numer modelu: **4040--40**

Type: **40**  
Typ: **40**

Blatt Nr: **4** von: **4**  
Strona: **4** z: **4**

